

Classic Mistake No.1

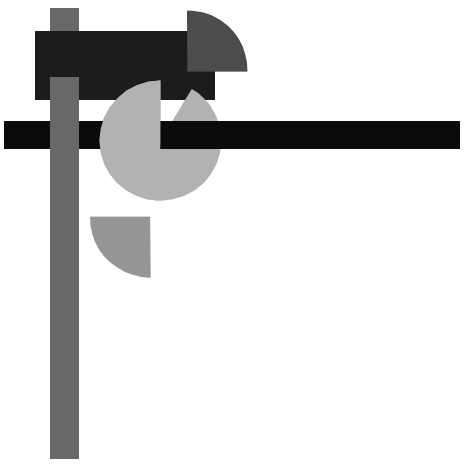

$$370000 = 3.7^5$$

X

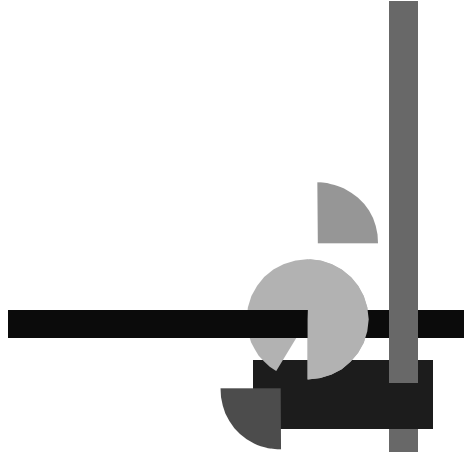

“Standard Flop”

Classic Mistake No2

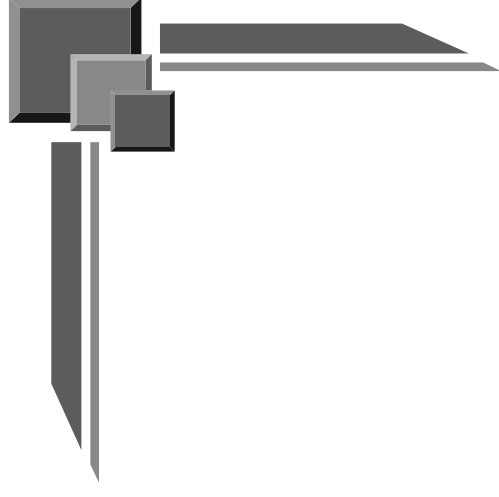

3 • 1hrs = 3hr 10m

X



“A Mile Off”

Classic Mistake No3

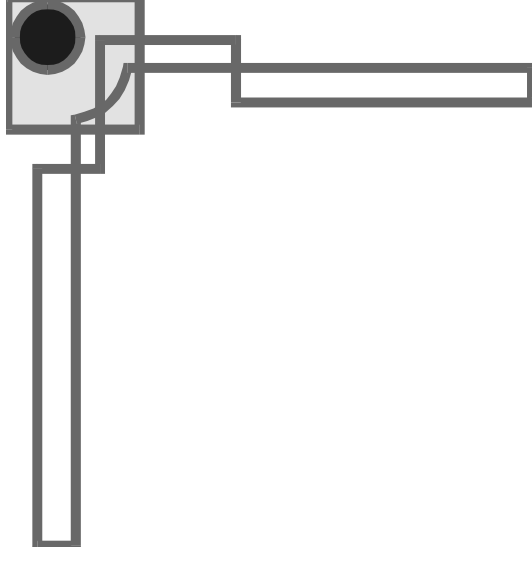

$$4 \times 5 = 20 \times 6 = 120 \div 2 = 60$$

X

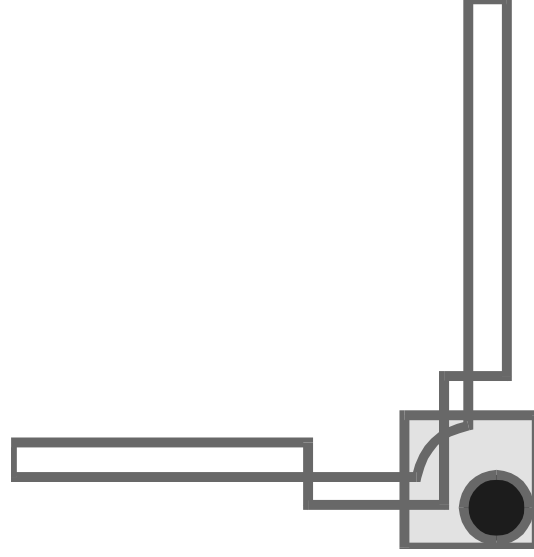

“Unequal Equals”

Classic Mistake No4



Solving $2x^2 - 5x - 2 = 0$ gives

$a = 2$, $b = -5$, $c = -2$

$$x = \frac{-b \pm \sqrt{b^2 - 4ac}}{2a}$$

$$= \frac{5 \pm \sqrt{-5^2 - 4 \times 2 \times (-2)}}{2 \times 2}$$

$$= \frac{5 \pm \sqrt{-25 + 16}}{4}$$

$$= \frac{5 \pm \sqrt{-9}}{4}$$

X



“Discriminating Discriminant”

Classic Mistake No5

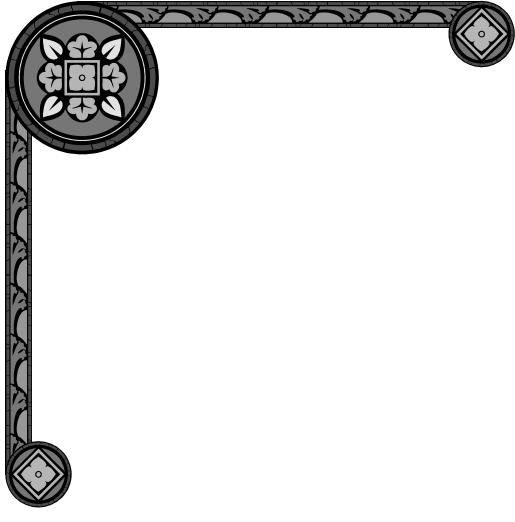

$$3x = -4$$

$$x = -1.3$$

X

“Recurring Rounding”

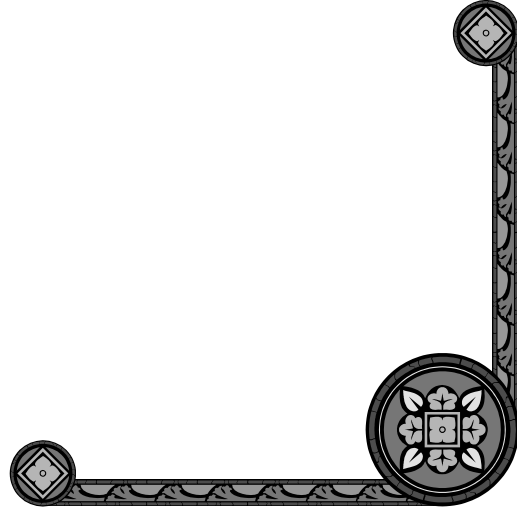

Classic Mistake N°6



$$5650000 = 565 \times 10^4$$



“Substandard Form”

Classic Mistake No.7

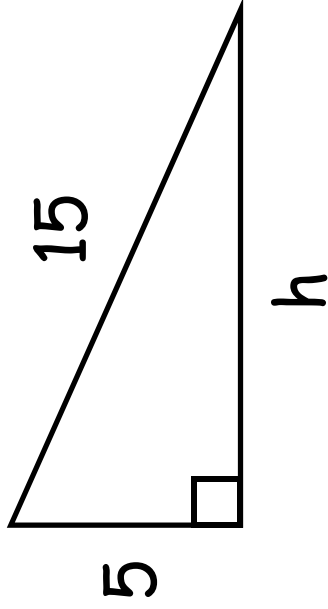

$$\begin{aligned}h^2 &= 15^2 + 5^2 \\ &= 225 + 25 \\ &= 250\end{aligned}$$

$$\begin{aligned}h &= \sqrt{250} \\ &= 5\sqrt{10}\end{aligned}$$

X

“Pythagoras’ Trauma”

Classic Mistake N°8

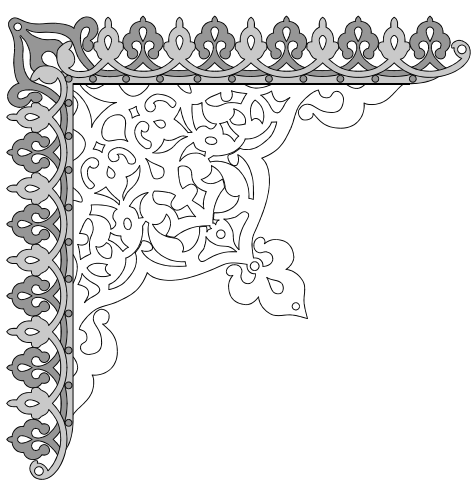

6.7hrs = 6hr 70m

= 7hr 10m

X

“Overtime”

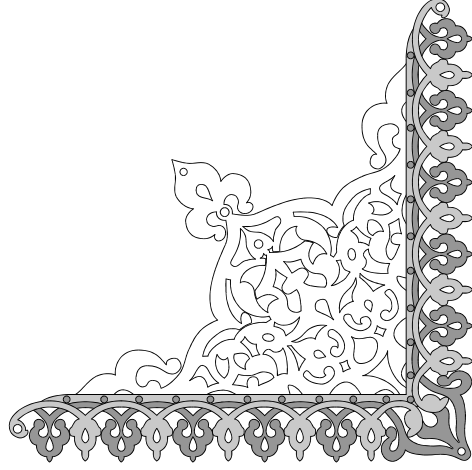

Classic Mistake No9



$$(-1)^2 = -1$$

X



" - X - = + "

Classic Mistake N^o10



$$3^2 = 6$$

$$5^3 = 15$$

X

*“2’s a Company,
3’s a Crowd”*





Classic Mistake No. 11

Finishing an exam early and
then sitting doing nothing



“Check Mate”

Classic Mistake No 12

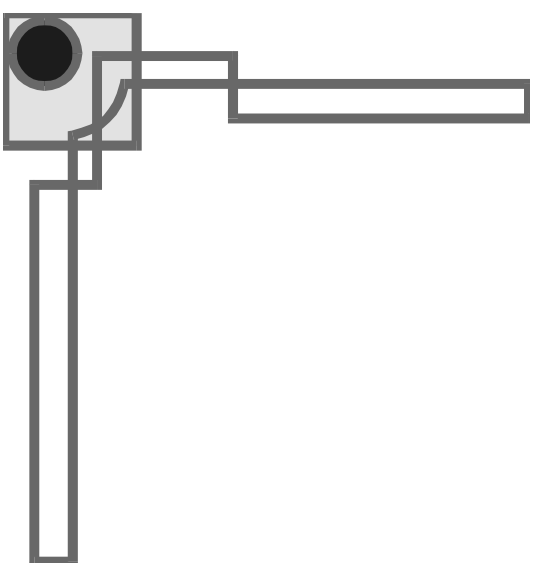

$$1 \times 1 = 2$$

X

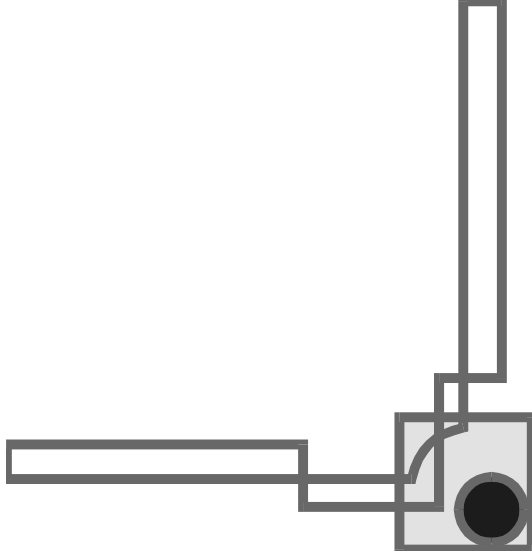

“Double or Quits”

Classic Mistake N°13



$$7 \times 0 = 7$$

X



“Nothing Comes of Nothing”

Classic Mistake No 14

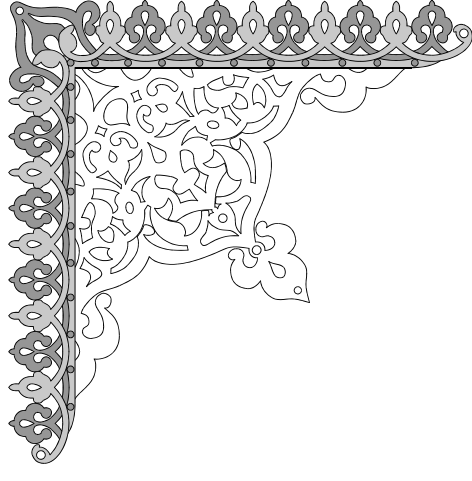

$$5a + 7 - 2a = 10a$$

X

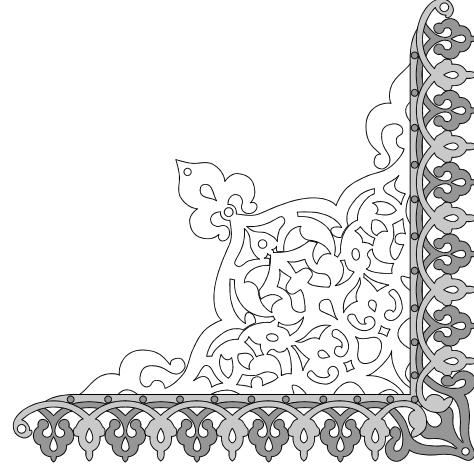

“Collection Chaos”

Classic Mistake N°15

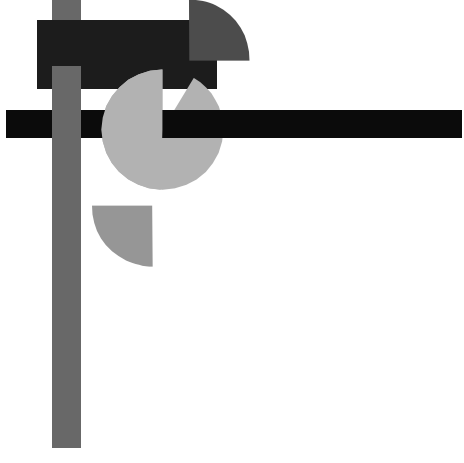

1 is a prime number

X

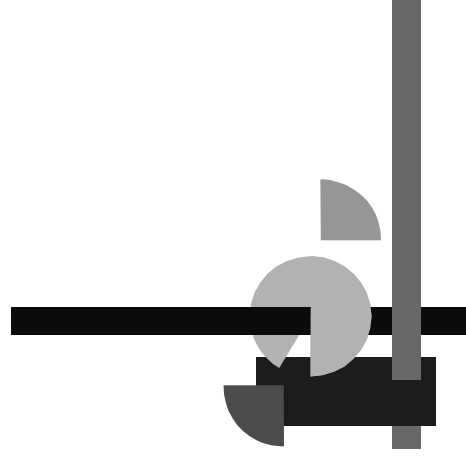

“Composite Crime”

Classic Mistake No 16

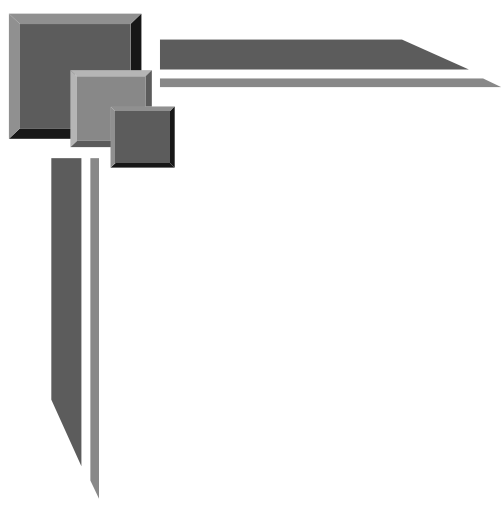

$$(b+1)^2 = b^2 + 1$$

X

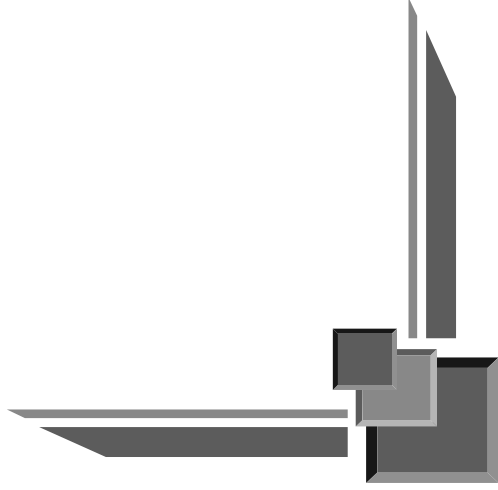

“2b or not 2b”

Classic Mistake No 17



$$5(2p+7) \\ = 10p+7$$

X



“Partial Expansion”

Classic Mistake N°18



$$\frac{1}{3} + \frac{4}{7} = \frac{5}{10}$$

X



“Highest Common Farcé”

Classic Mistake No 19



$$9 - 3 \times 2 = 12$$

X



“Take it as it Comes”

Classic Mistake N^o20

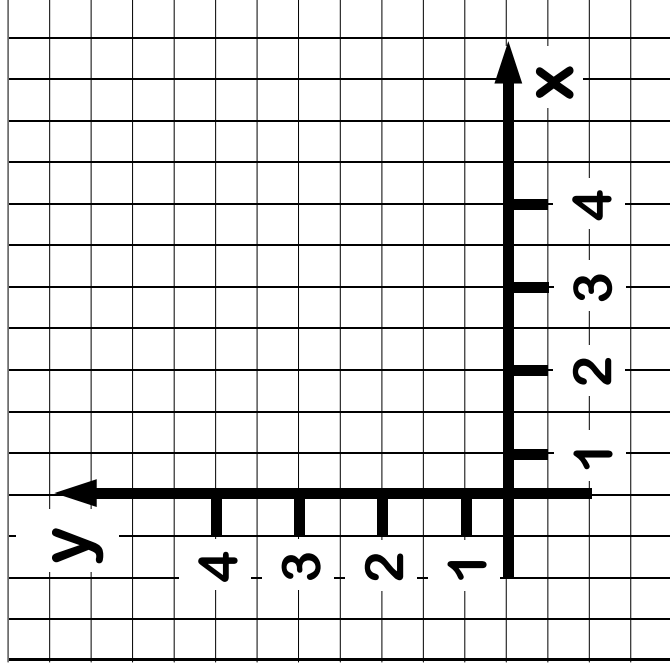

X

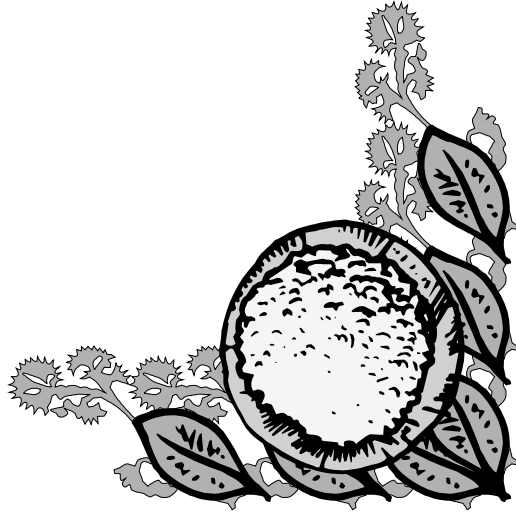

“Mind the Gap”

Classic Mistake No 21

x	y
2	5
3	8
5	14
8	23

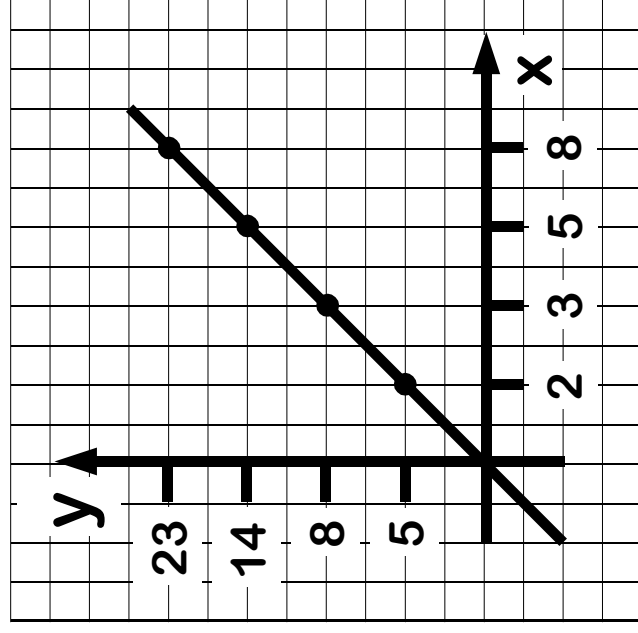

X

“Dire Straights”

Classic Mistake N^o22



16cm

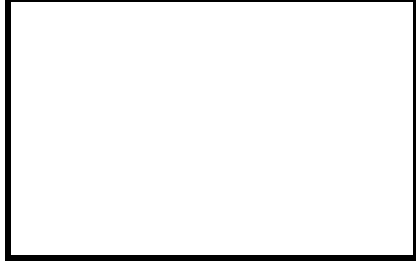

25cm

$$\begin{aligned}\text{Area} &= 25 \times 16 \\ &= 400\text{cm}^2 \\ &= 4\text{m}^2\end{aligned}$$

X

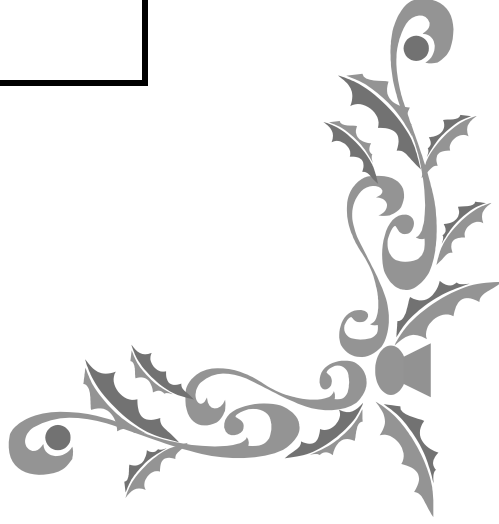

“1m = 100cm”

Classic Mistake N^o23

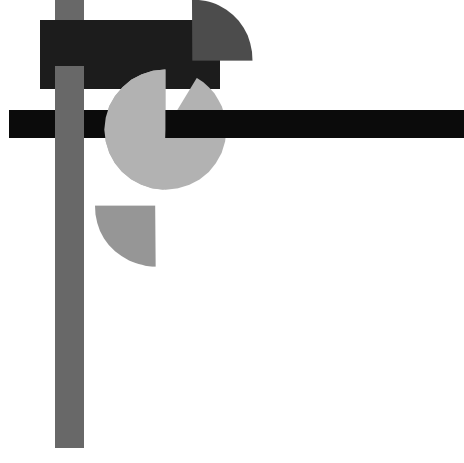

$$(-6)^2 = -6^2$$

X

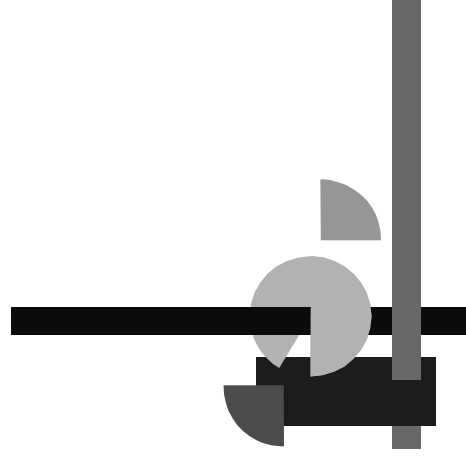

“Sign Language”

Classic Mistake N^o24

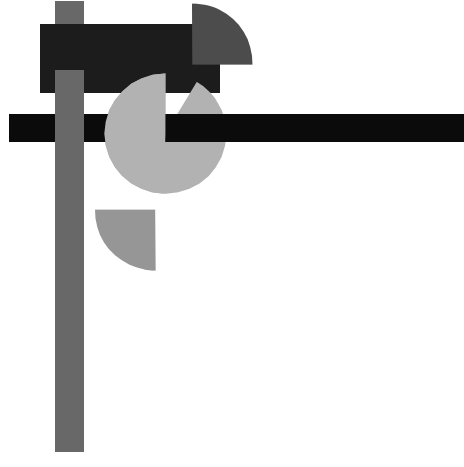

$$(3p^2)^4 = 3p^8$$

X

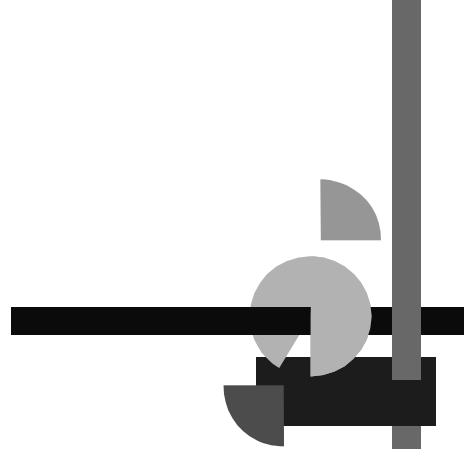

“Powerless”

Classic Mistake No 25

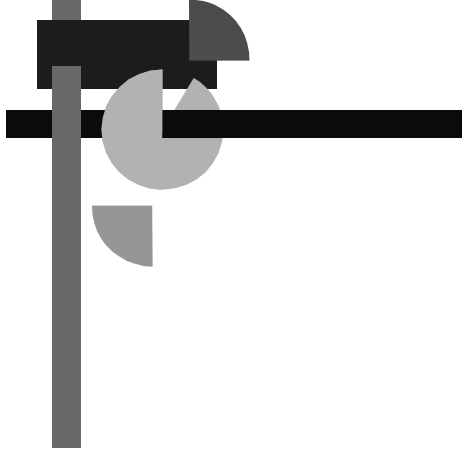

$$3^7 + a = a^{10}$$

X

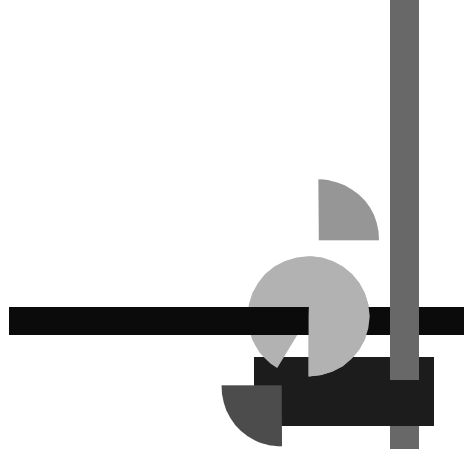

“Done Sum Times”

Classic Mistake N^o26

$$\frac{1}{2x} = 2x^{-1}$$

X

“Too Easy By Half”

Classic Mistake No 27

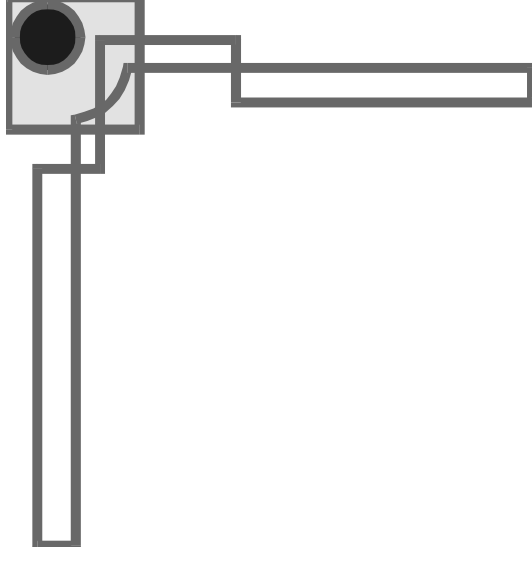

$$\text{meal} \times \text{meal} = 2\text{meal}$$

$$y \times y = 2y \quad \mathbf{X}$$

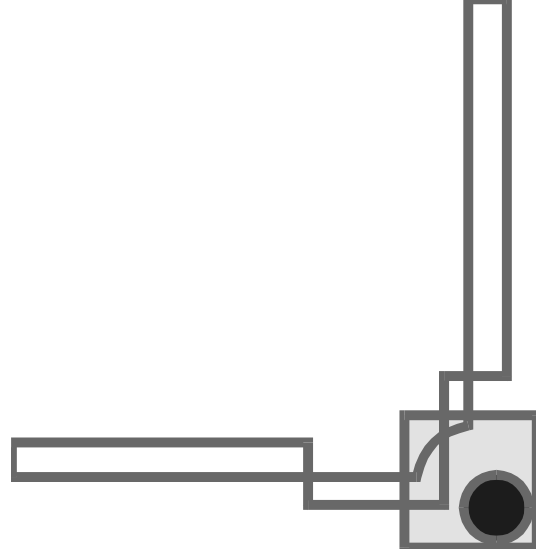

“A Square Meal”

Classic Mistake N^o28



$$0.5 \times 0.5 = 2.5$$

X



“A Point Worth Noting”

Classic Mistake N^o29

$$\sqrt{a^2 + b^2} = a + b$$

$$\sqrt{60 + 6} = \sqrt{60} + \sqrt{6}$$

X

“Root 66”

Classic Mistake N°30



$$-(7a + 6) = -7a + 6$$

X



“Winner Takes All”

Classic Mistake No 31

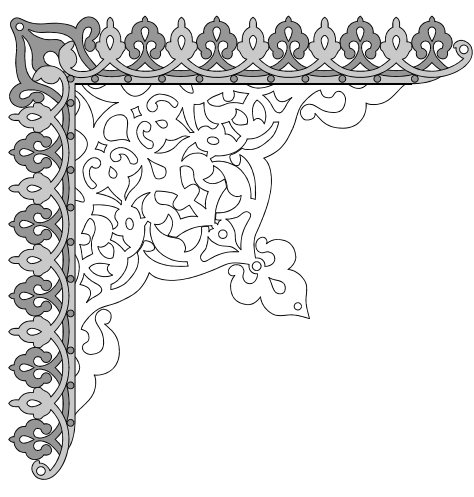

$$9 - 3(x + 2) \\ = 6(x + 2)$$

X

“First Come, Last Served”

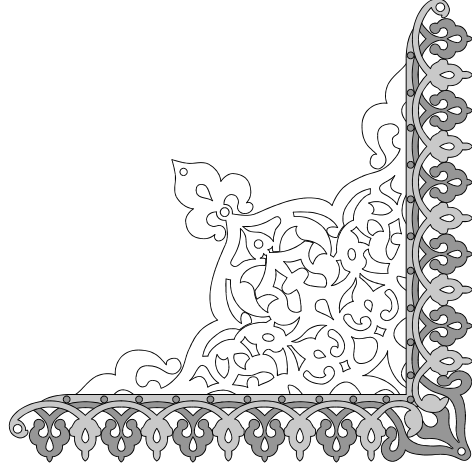

Classic Mistake N°32



Not drawing a
helpful diagram



“Quick Draw”

Classic Mistake N°33

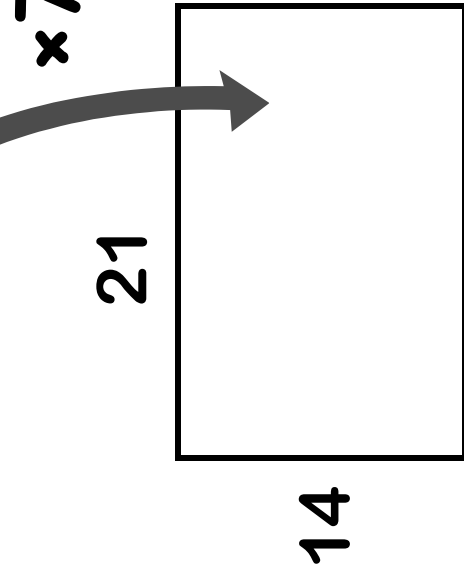
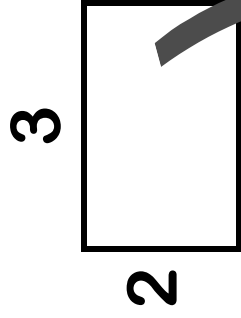

$$\begin{aligned} \text{Old Area} &= 2 \times 3 \\ &= 6\text{cm}^2 \end{aligned}$$

$$\begin{aligned} \text{New Area} &= \text{Old Area} \times 7 \\ &= 42\text{cm}^2 \end{aligned}$$

X

“Scale it Up & Up”

Classic Mistake No34

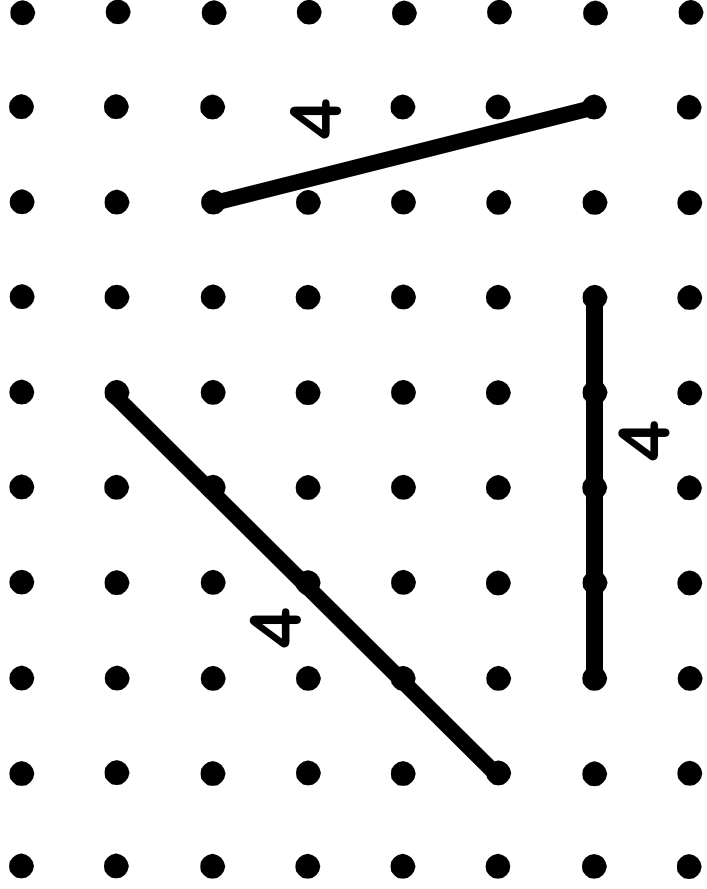
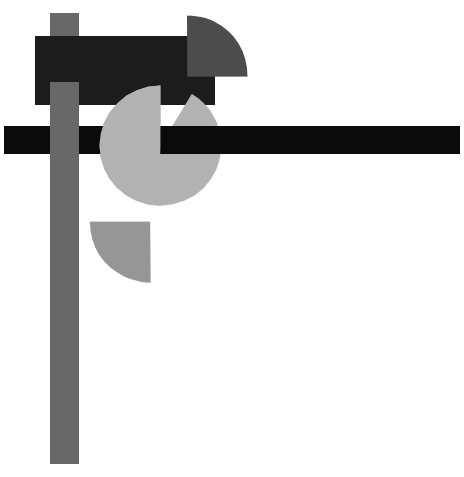

X

“Four Lines”

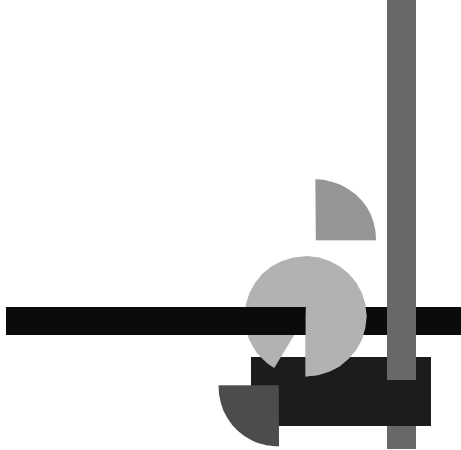

Classic Mistake No 35

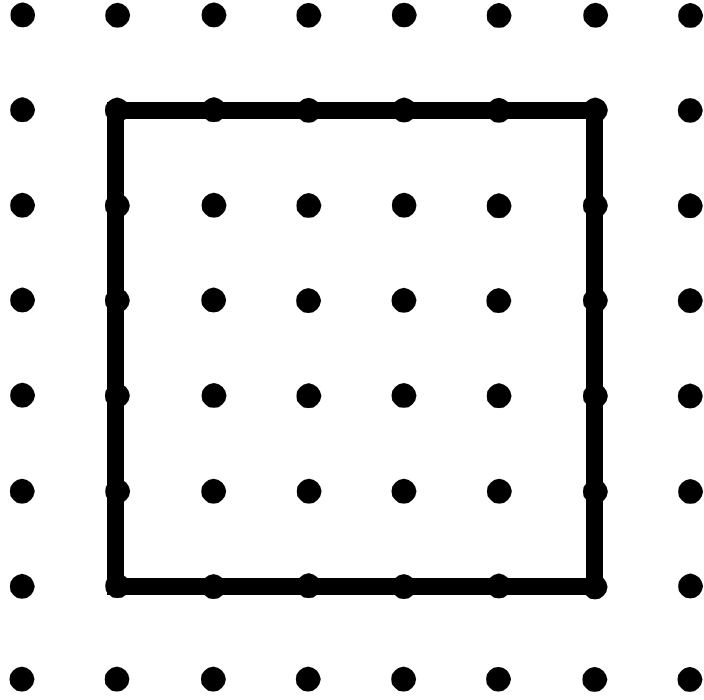
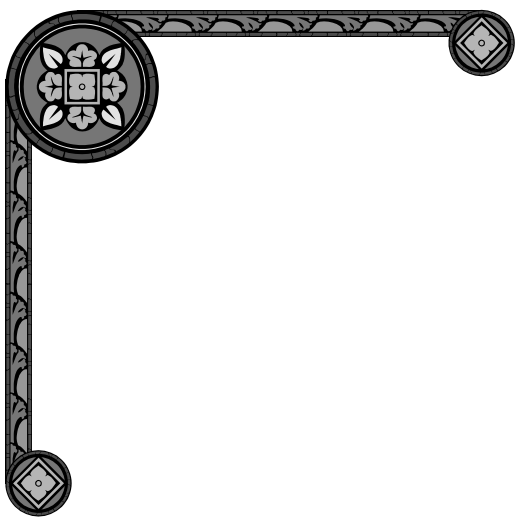

Perimeter=16

X

“Counting Boxes”

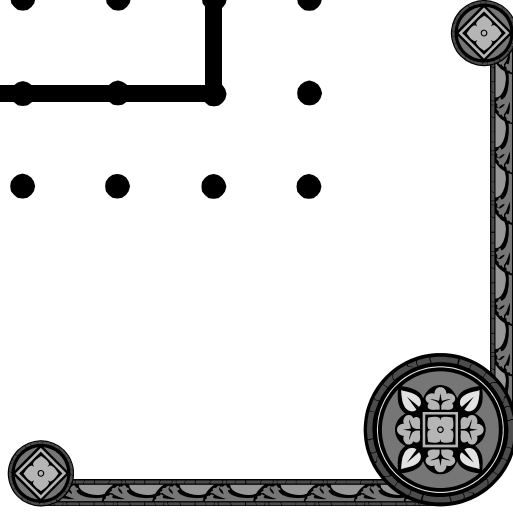

Classic Mistake No36

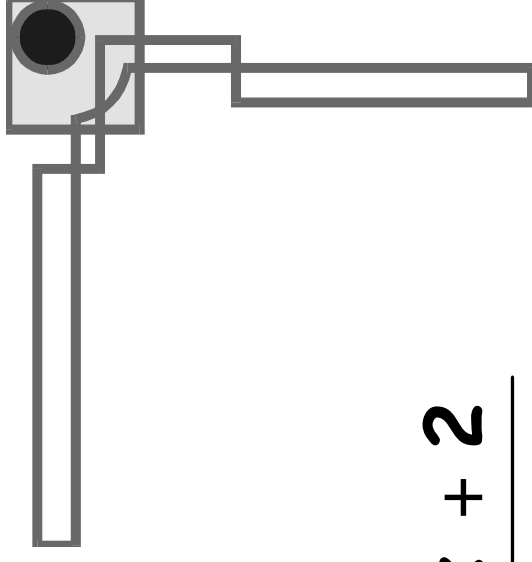

$$\frac{x^2 + 3x + 2}{x^2 + 4x + 3} = \frac{\cancel{x^2} + 3x + 2}{\cancel{x^2} + 4x + 3} = \frac{\cancel{3x} + 2}{\cancel{4x} + 3} = \frac{2}{x + 3}$$

X

“Cancel Crazy”

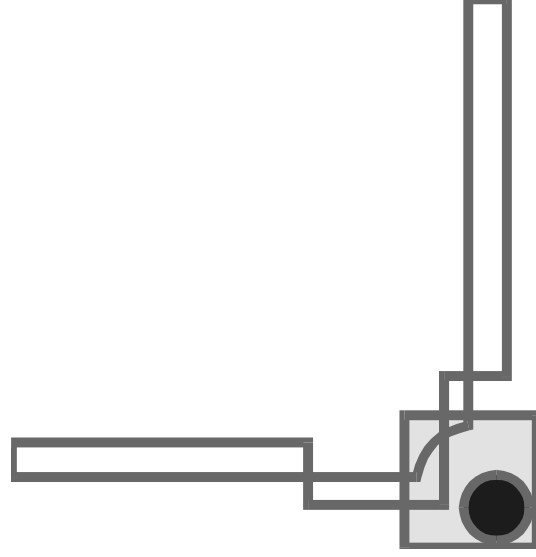

Classic Mistake No37



Only writing down
the answer



“Working Class”

Classic Mistake N^o38

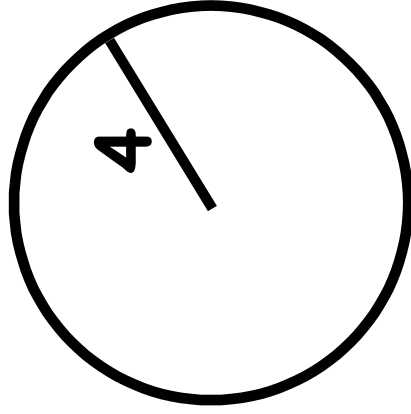
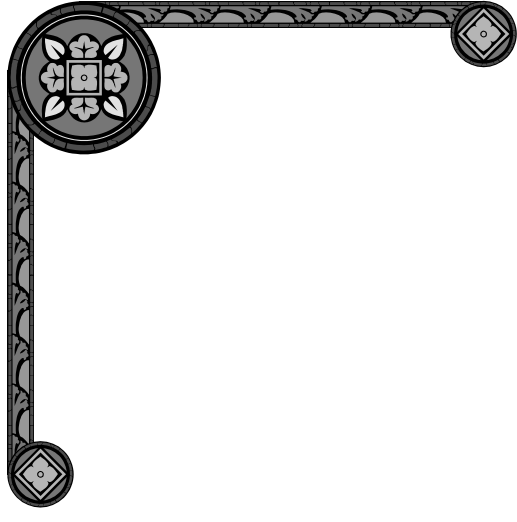

$$A = \pi r^2$$

$$= 3.14 \times 4^2$$

$$= 12.56^2$$

$$\approx 157.8\text{cm}^2$$

X

“A = π not squared”

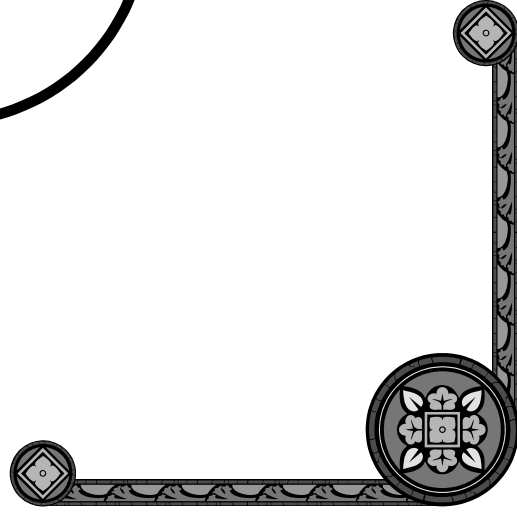

Classic Mistake N^o39



Not having all
the equipment

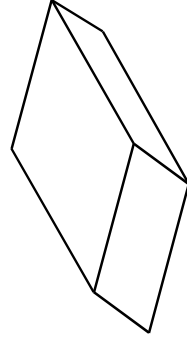

“An Uncalculated Move”

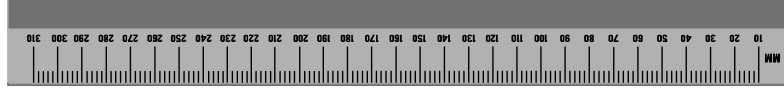

Classic Mistake N^o40

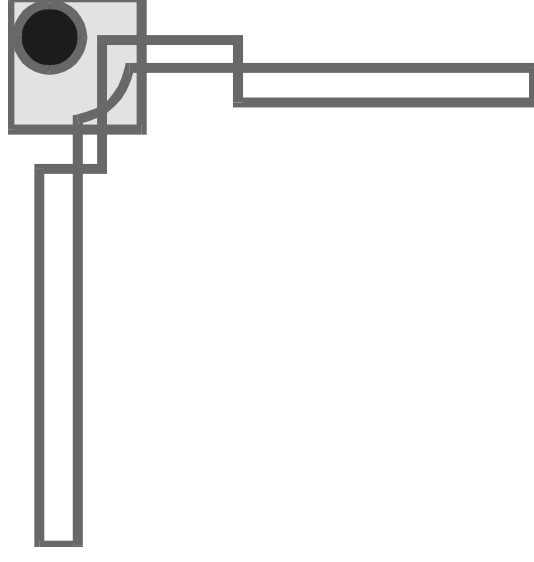

$$5 \left(\frac{4x}{3} \right) = \frac{20x}{15}$$

X

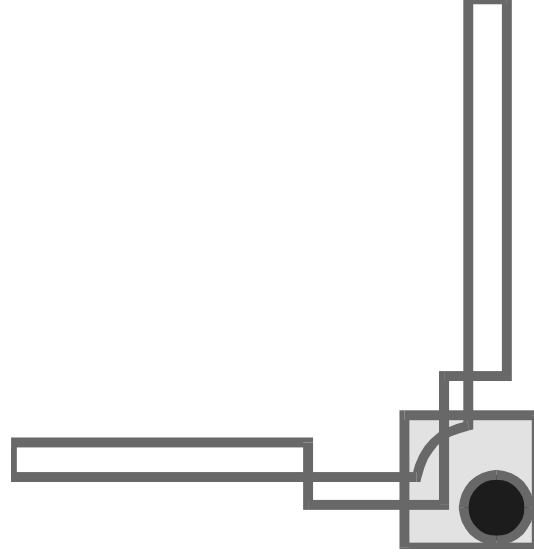

“Cancelled Out”

Classic Mistake No41



Trying to do too
much all at once



“Walk before you Fall”

Classic Mistake N^o42



$$\frac{1}{a} + \frac{1}{b} = \frac{1}{a+b}$$

X



“The Bottom Line”

Classic Mistake N^o43



$$4 \times 2y + 3 = 8y + 12$$

X



“Invisible Brackets”

Visit www.ClassicMistake.co.uk to hear this poster's Podcast!

This Classic Mistake was submitted by R. Catterall

Classic Mistake No44

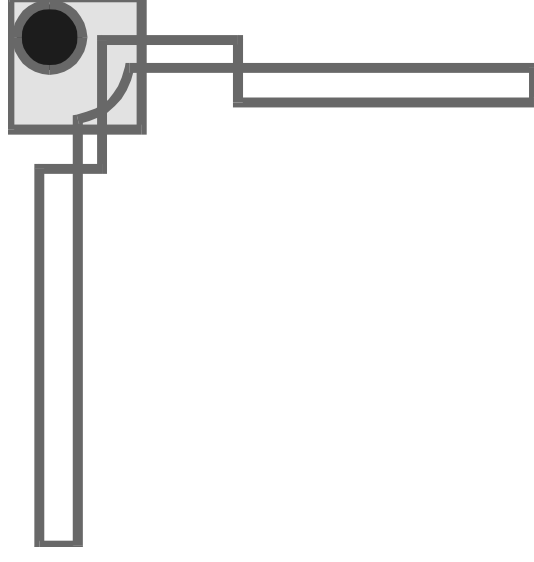

$$\frac{\sin 6x}{\sin 3x} = \frac{6x}{3x} = 2$$

X

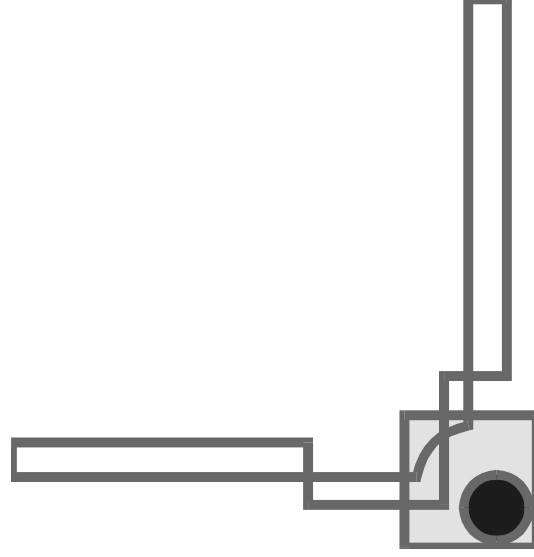

“A Sin of the Times”

Classic Mistake No45

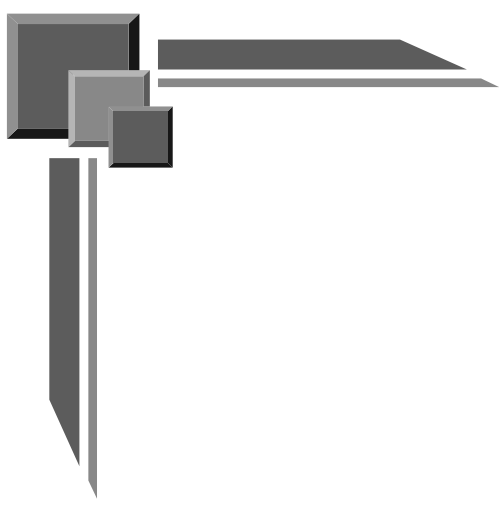

$$(-7) \times (-7) = -49$$

X

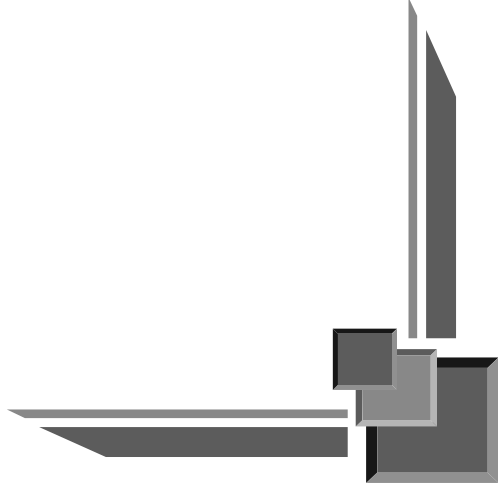

“Negative times a Negative”

Visit www.ClassicMistake.co.uk to hear this poster's Podcast!

This Classic Mistake was submitted by K Tsalikidis

Classic Mistake N^o46

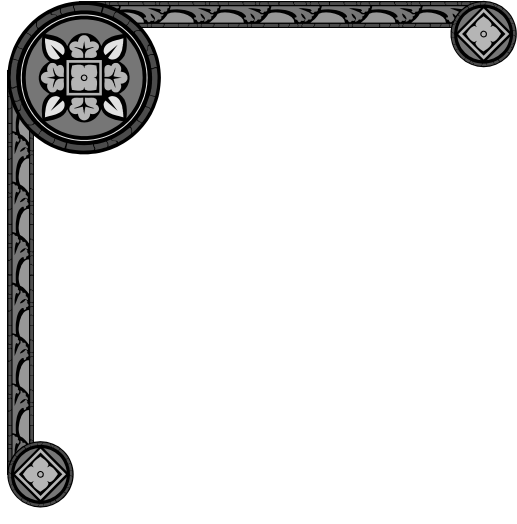

$P(\text{roll a 4 on a die}) = 1:6$

X

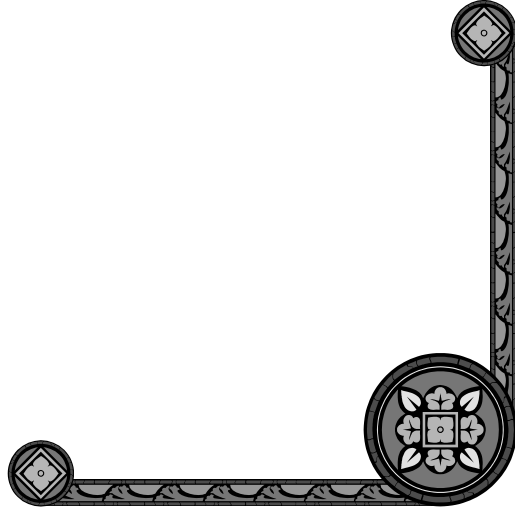

“Irrational Probability”

Visit www.ClassicMistake.co.uk to hear this poster's Podcast!

This Classic Mistake was submitted by Dr Tebbutt

Classic Mistake No 47

data	freq	$d \times f$
4	1	4
5	2	10
6	1	6
7	4	28
		48

$$\text{mean} = \frac{48}{4} = 12$$

X

“Pieces of Data”

Classic Mistake N°48

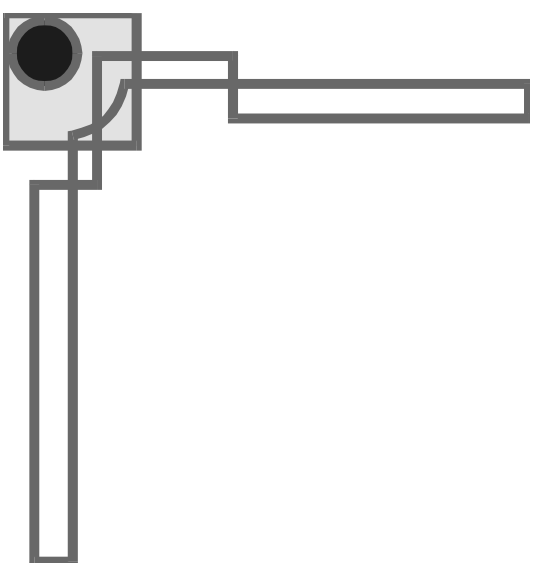

Your suggestion
could be here

X

“And Your Title”

